



Drip System Utilities

Fittings



Connectors

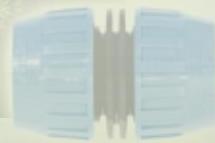

PE pipes



Fittings

Netafim™ Accessories & Fittings Components product families are designed to complement and support efficient and professional utilization of low volume irrigation systems.

Netafim™ Accessories & Fittings Components are an integral part of your irrigation system. Each component is manufactured under the strictest quality control standards ensuring maximum system performance and reliability.

The Netafim™ Accessories & Fittings Components comprise features that make them stand out above others.



Manifolds - a wide range of models



Stakes - different models



Handling accessories - different models





DNL, prevents drainage of dripperlines and sub-main pipes





Auto-Flushing valves

Description	Elbow adapter barb 3*5 Inlet: female press-fit		
	For correct customized installation		
Catalog numbers	1 unit 50 units/bag 100 units/bag	32000-002520 32000-002525	

Description	Elbow adapter barb 3*5 Inlet: female press-fit, colored gray		
	For correct customized installation		
Catalog numbers	1 unit 50 units/bag 100 units/bag	32000-002526	

Description	"T" adapter barb 3*5 Inlet: female press-fit		
	To distribute water to 2 different points		
Catalog numbers	1 unit 50 units/bag 100 units/bag	32000-002530 32000-002537 32000-002538	

Description	"T" adapter barb 3*5 Inlet: female press-fit, colored gray		
	To distribute water to 2 different points		
Catalog numbers	1 unit 50 units/bag 100 units/bag	32000-002550	

Description	Flat manifold, 4 outlets Inlet: female press-fit		
	To distribute water to 4 different points		
Catalog numbers	1 unit 50 units/bag 100 units/bag	32000-002560 32000-002567 32000-002570	

Description	Flat manifold, 4 outlets Inlet: female press-fit, colored gray		
	To distribute water to 4 different points		
Catalog numbers	1 unit 50 units/bag 100 units/bag	32000-002590	

Description	Flat manifold, 4 outlets w/nipple outlet Inlet: female press-fit		
	To distribute water to 5, 6 or 8 different points (with additional manifold).		
Catalog numbers	1 unit 50 units/bag 100 units/bag	32000-002580 32000-002587 32000-002589	

Description	Straight manifold, 4 outlets Inlet: female press-fit		
	To distribute water to 4 different points		
Catalog numbers	1 unit 50 units/bag 100 units/bag	32000-002400 32000-002420 32000-002430	

Description	Straight manifold, 2 outlets CapiNet size Inlet: female press-fit		
	To distribute water to 2 different points		
Catalog numbers	500 units/bag	32000-002245	

Description	Straight manifold, 2 outlets CapiNet size Inlet: female press-fit, colored gray		
	To distribute water to 2 different points		
Catalog numbers	500 units/bag	32000-002260	

Description	Straight manifold, 4 outlets CapiNet size Inlet: female press-fit		
	To distribute water to 4 different points		
Catalog numbers	500 units/bag	32000-002275	

Description	Straight manifold, 4 outlets CapiNet size Inlet: female press-fit, colored gray		
	To distribute water to 4 different points		
Catalog numbers	500 units/bag	32000-002290	

50 and 100 units/bag available upon request.

Description	Straight manifold, 8 outlets Inlet: 1/2" male threaded		
	To distribute water to 8 different points		
Catalog numbers	1 unit	32000-002300	
	50 units/bag	32000-002320	
	100 units/bag	32000-002330	

Description	Cap for nipple outlet colored brown		
	To stop irrigation (inserted on the outlet nipple of PC, PCJ or Button drippers)		
Catalog numbers	1 unit	32000-001400	
	50 units/bag	32000-001420	
	100 units/bag	32000-001430	

Description	Barb connector to a 3*5 micro-tube or a press-fit connection		
	To connect a PE pipe to a micro-tube 3*5 or to a manifold		
Catalog numbers	1 unit	32000-001900	
	50 units/bag	32000-001920	
	100 units/bag	32000-001930	

Description	Barb connector to a 3*5 micro-tube or a press-fit connection., colored brown.		
	To connect a PE pipe to a micro-tube 3*5 or to a manifold		
Catalog numbers	1 unit	32000-001850	
	50 units/bag	32000-001860	
	100 units/bag	32000-001870	

Description	Micro-tube adapter Outlet: barb 3*5 Inlet: press-fit		
	To connect a dripper nipple outlet to a micro-tube 3*5		
Catalog numbers	1 unit	32000-001950	
	50 units/bag		
	100 units/bag		

Description	Micro-tube adapter Outlet: barb 3*5 Inlet: press-fit, colored brown		
	To connect a dripper nipple outlet to a micro-tube 3*5		
Catalog numbers	1 unit	32000-002000	
	50 units/bag	32000-002010	
	100 units/bag	32000-002020	

Description	Micro-tube adapter Outlet: barb 4*6.5 Inlet: press-fit		
	To connect a dripper nipple outlet to a micro-tube 4*7		
Catalog numbers	1 unit	32000-002100	
	50 units/bag	32000-002115	
	100 units/bag	32000-002130	

Description	Double plug 3 and 7 mm		
	To plug holes in PE pipes		
Catalog numbers	1 unit	32000-001000	
	50 units/bag	32000-001020	
	100 units/bag	32000-001030	

Description	Plug 5 mm		
	To plug holes in PE pipes		
Catalog numbers	1 unit	32000-001100	
	50 units/bag	32000-001110	
	100 units/bag	32000-001120	

Description	Plug 8 mm		
	To plug holes in PE pipes		
Catalog numbers	1 unit	32000-001200	
	50 units/bag	32000-001210	
	100 units/bag		

Description	Ring adapter Outlet: barb 3*5		
	To connect outlet hole of an integral dripper to a 3*5 micro		
Catalog numbers	1 unit	32000-006300	
	50 units/bag	32000-006320	
	100 units/bag	32000-006330	

Description	Ring adapter Outlet: barb 3*5, colored brown		
	To connect outlet hole of an integral dripper to a 3*5 micro-tube		
Catalog numbers	1 unit	32000-006400	
	50 units/bag	32000-006420	
	100 units/bag		

50 and 100 units/bag available upon request.

Description	Clip to handle 16, 17 & 18 mm OD tube		
	Prevents flux of drops down the tube (to be assembled in the production line)		
Catalog numbers	1 unit	32000-003330	
	50 units/bag		
	100 units/bag		

Description	Clip to handle 16, 17 & 18 mm OD tube colored violet		
	Prevents flux of drops down the tube (to be assembled in the production line)		
Catalog numbers	1 unit	32000-003310	
	50 units/bag		
	100 units/bag		

Description	Clip to handle 20 mm OD tube		
	Prevents flux of drops down the tube (to be assembled in the production line)		
Catalog numbers	1 unit	32000-003360	
	50 units/bag		
	100 units/bag	32000-003375	

Description	Clip to handle 20 mm OD tube, colored gray		
	Prevents flux of drops down the tube (to be assembled in the production line)		
Catalog numbers	1 unit	32000-003380	
	50 units/bag		
	100 units/bag		

Description	Smart clip to handle 16 & 17 mm OD tube		
	For correct handling of irrigation pipe Prevents flux of drops down the tube		
Catalog numbers	1 unit	32000-003400	
	50 units/bag	32000-003420	
	100 units/bag		

Description	Anti spill clip to handle 16 & 17 mm OD tube		
	For correct handling of irrigation pipe Prevents flux of drops down the tube in both sides of the dripper		
Catalog numbers	1 unit	32000-003500	
	50 units/bag	32000-003520	
	100 units/bag	32000-003530	

Description	Ring plug for 16 & 17 mm OD dripperline, colored brown		
	To plug outlet of integral dripper		
Catalog numbers	1 unit	32000-006000	
	50 units/bag	32000-006020	
	100 units/bag	32000-006030	

Description	Ring plug for 20 mm OD dripperline, colored brown		
	To plug outlet of integral dripper		
Catalog numbers	1 unit	32000-006150	
	50 units/bag	32000-006160	
	100 units/bag	32000-006170	

Description	Plug for 12, 16, 17, 20 & 23 mm OD dripperline colored red		
	To plug outlet of integral dripper		
Catalog numbers	100 units/bag	32000-011000	
	1000 units/bag	32000-011050	

Description	Adapter for 12, 16, 17, 20 & 23 mm OD dripperline colored blue		
	To connect outlet hole of integral dripper to a Netafim manifold		
Catalog numbers	100 units/bag	32000-011200	
	1000 units/bag	32000-011250	

Description	Tying device for 12, 16, 17, 20 & 23 mm OD dripperline colored violet		
	For correct handling of PE pipes		
Catalog numbers	100 units/bag	32000-011400	
	1000 units/bag	32000-011415	

Description	Tying device for 12, 16, 17, 20 & 23 mm OD dripperline colored gray		
	For correct handling of PE pipes		
Catalog numbers	100 units/bag	32000-011450	
	1000 units/bag	32000-011480	

50 and 100 units/bag available upon request.

Description	Spike for 3*5 micro-tube		
	Precise positioning of micro-tube		
Catalog numbers	1 unit	32000-001801	
	50 units/bag	32000-001803	
	100 units/bag	32000-001804	

Description	Spike for 3*5 micro-tube colored gray		
	Precise positioning of micro-tube		
Catalog numbers	1 unit	32000-001830	
	50 units/bag		
	100 units/bag		

Description	Short spike for 3*5 micro-tube		
	Precise positioning of micro-tube		
Catalog numbers	1 unit	32000-001740	
	50 units/bag		
	100 units/bag		

Description	Short spike for 3*5 micro-tube colored gray		
	Precise positioning of micro-tube		
Catalog numbers	1 unit	32000-001835	
	50 units/bag		
	100 units/bag		

Description	Mini stake for CapiNet™ dripper		
	Precise positioning of CapiNet™		
Catalog numbers	3000 units	32000-006860	

Description	Mini stake for CapiNet™ dripper , colored gray		
	Precise positioning of CapiNet™		
Catalog numbers	3000 units	32000-006880	

Description	Stake for 8 mm OD tube		
	To fix position of pipe (Height 11 cm)		
Catalog numbers	1 unit	32500-002150	
	50 units/bag	32500-002162	
	100 units/bag	32500-002170	

Description	Metal stabilizer		
	4 mm (Height 14 cm)		
Catalog numbers	1 unit	32000-001600	
	50 units/bag		
	100 units/bag		

Description	Stake for 16 & 17 mm OD tube		
	To fix position of pipe (Height 15 cm)		
Catalog numbers	1 unit	32000-006550	
	50 units/bag	32000-006562	
	100 units/bag	32000-006570	

Description	Stake for 16 & 17 mm OD tube colored brown		
	To fix position of pipe (Height 15 cm)		
Catalog numbers	1 unit	32000-006600	
	50 units/bag	32000-006020	
	100 units/bag	32000-006030	

Description	Stake for 20 mm OD tube		
	To fix position of pipe (Height 15 cm)		
Catalog numbers	1 unit	32000-006700	
	50 units/bag	32000-006720	
	100 units/bag	32000-006730	

Description	Stake for 20 mm OD tube colored brown		
	To fix position of pipe (Height 15 cm)		
Catalog numbers	1 unit	32000-006800	
	50 units/bag		
	100 units/bag		

50 and 100 units/bag available upon request.

Description	Stake for 5 & 6.5 mm OD Micro-tube		
	To stabilize the Pot, Button, PC or PCJ dripper in its place. Adaptable to 3*5 and 4*7 microtubes. (Height 10 cm)		
Catalog numbers	1 unit	32000-001500	
	50 units/bag	32000-001520	
	100 units/bag	32000-001540	

Description	Stake for 5 & 6.5 mm OD Micro-tube colored gray		
	To stabilize the Pot, Button, PC or PCJ dripper in its place. Adaptable to 3*5 and 4*7 microtubes. (Height 10 cm)		
Catalog numbers	1 unit	32000-001570	
	50 units/bag	32000-001580	
	100 units/bag		

Description	DNL – Dripperline non leakage fast 16 connector w/o rings, shuts-off at 0.2 bar, red cap.		
	Prevents main, sub-main and dripperlines water drainage		
Catalog numbers	1 unit	32000-004160	
	50 units/bag		
	100 units/bag		

Description	DNL – Dripperline non leakage 1/2" male threaded connector, shuts-off at 0.2 bar, red cap.		
	Prevents main, sub-main and dripperlines water drainage		
Catalog numbers	1 unit	32000-004120	
	50 units/bag		
	100 units/bag		

Description	DNL – Dripperline non leakageFast 16 connector w/o rings, shuts-off at 0.4 bar, black cap.		
	Prevents main, sub-main and dripperlines water drainage		
Catalog numbers	1 unit	32000-004170	
	50 units/bag		
	100 units/bag		

Description	DNL – Dripperline non leakage 1/2" male threaded connector, shuts-off at 0.4 bar, black cap.		
	Prevents main, sub-main and dripperlines water drainage		
Catalog numbers	1 unit	32000-004130	
	50 units/bag		
	100 units/bag		

Description	DNL – Dripperline non leakage fast 16 connector w/o rings, shuts-off at 0.8 bar, brown cap.		
	Prevents main, sub-main and dripperlines water drainage		
Catalog numbers	1 unit	32000-004180	
	50 units/bag		
	100 units/bag		

Description	DNL – Dripperline non leakage 1/2" male threaded connector, shuts-off at 0.8 bar, brown cap.		
	Prevents main, sub-main and dripperlines water drainage		
Catalog numbers	1 unit	32000-004140	
	50 units/bag		
	100 units/bag		

Description	Dripperline flushing valve fast 16 connector (w/o ring)		
	Proper flushing of dripperlines		
Catalog numbers	1 unit	32000-007800	
	50 units/bag		
	100 units/bag		

Description	Dripperline flushing valve fast 16 connector (w/o ring) colored brown		
	Proper flushing of dripperlines		
Catalog numbers	1 unit	32000-007900	
	50 units/bag		
	100 units/bag		

Description	Pressure indicator Complete assembly		
	Provides visual indication of water pressure		
Catalog numbers	1 unit	32000-002800	
	50 units/bag		
	100 units/bag		

Description	Dripperline flushing valve 1/2" male threaded connector colored brown		
	Proper flushing of dripperlines		
Catalog numbers	1 unit	32000-007850	
	50 units/bag		
	100 units/bag		

50 and 100 units/bag available upon request.

Description	Vacuum breaker 1/2" male threaded connector		
	Protects dripperlines from excessive vacuum and collapse		
Catalog numbers	1 unit 50 units/bag 100 units/bag	32000-008400	

Description	Micro-tube weight		
	To improve the position of Pot, Button, PC or PCJ drippers		
Catalog numbers	1 unit 50 units/bag 100 units/bag	32000-002200	

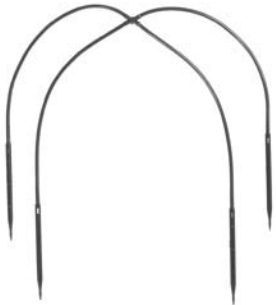
Description	Start product Flat manifold x 4 outlet		
	Micro-tube SPE micro-tube 3*5, 60 cm length, black		
Catalog numbers	End line product Straight w/splitter arrow dripper 2.3		
	1 unit 50 units/bag 100 units/bag	40200-001900	

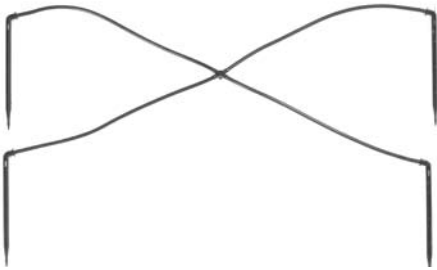
Description	Start product Flat manifold x 4 outlet		
	Micro-tube SPE micro-tube 3*5, 60 cm length, black		
Catalog numbers	End line product Angled long arrow dripper 2.3		
	1 unit 50 units/bag 100 units/bag	40200-006000	

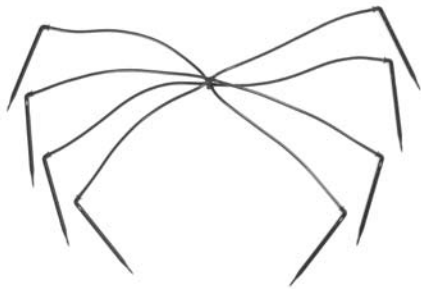
Description	Start product Flat manifold x 4 outlet + flat manifold x 4 outlets w/nipple		
	Micro-tube SPE micro-tube 3*5, 40 cm length, black		
Catalog numbers	End line product Angled long arrow dripper 2.3		
	1 unit 50 units/bag 100 units/bag	40200-005992	

Description	Start product Upright manifold x 4 outlets		
	Micro-tube SPE micro-tube 3*5, 60 cm length, black		
Catalog numbers	End line product Spike 3*5		
	1 unit 50 units/bag 100 units/bag	40200-008000	

50 and 100 units/bag available upon request.

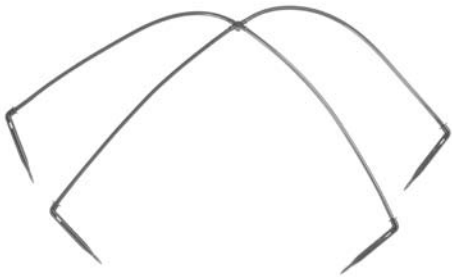
Description	Start product	Flat manifold x 4 outlet	
	Micro-tube		
Catalog numbers	1 unit	40200-009020	End line product
	50 units/bag		Angled short arrow dripper 2.3
	100 units/bag		

Description	Start product	"T" 5 mm connector	
	Micro-tube		
Catalog numbers	1 unit	40200-009300	End line product
	50 units/bag		Angled short arrow dripper 2.3
	100 units/bag		

Description	Start product	Flat manifold x 2 outlet	
	Micro-tube		
Catalog numbers	1 unit	40200-006600	End line product
	50 units/bag		Angled long arrow dripper 2.3
	100 units/bag		

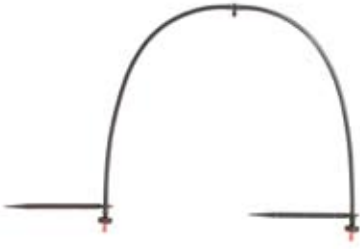
Description	Start product	"T" 5 mm connector	
	Micro-tube		
Catalog numbers	1 unit	40200-005230	End line product
	50 units/bag		PCJ LCNL 2 l/h. + stake
	100 units/bag		

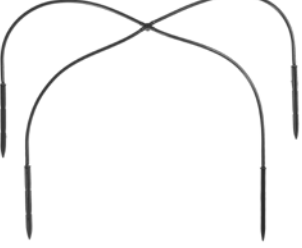
Description	Start product	Flat manifold x 4 outlet	
	Micro-tube		
Catalog numbers	1 unit	40200-001110	End line product
	50 units/bag		Straight arrow dripper 2.3
	100 units/bag		

50 and 100 units/bag available upon request.

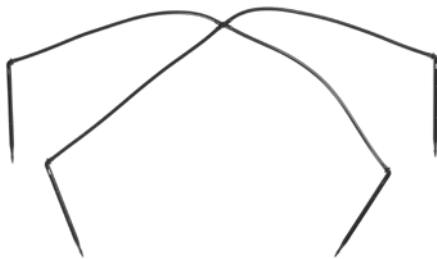
Description	Start product	Flat manifold x 4 outlet	
	Micro-tube		
Catalog numbers	1 unit	40200-007230	End line product
	50 units/bag		
	100 units/bag		

Description	Start product	"T" 5 mm connector	
	Micro-tube		
Catalog numbers	1 unit	40200-009100	End line product
	50 units/bag		
	100 units/bag		

Description	Start product	PCJ-LCNL 3 l/h	
	Micro-tube		
Catalog numbers	1 unit	40200-005290	End line product
	50 units/bag		
	100 units/bag		

Description	Start product	PCJ-LCNL 2 l/h	
	Micro-tube		
Catalog numbers	1 unit	40200-005000	End line product
	50 units/bag		
	100 units/bag		

Description	Start product	W/o start product	
	Micro-tube		
Catalog numbers	1 unit	40200-002900	End line product
	50 units/bag		
	100 units/bag		

50 and 100 units/bag available upon request.

Description	Start product Adapter to integral drippers		
	Micro-tube SPE micro-tube 3*5, 76.2 cm length, black		
	End line product Spike 3*5		
Catalog numbers	1 unit 50 units/bag 100 units/bag	40200-015000	

Description	Start product Flat manifold elbow one outlet		
	Micro-tube SPE micro-tube 3*5, 70 cm length, black		
	End line product Spike 3*5		
Catalog numbers	1 unit 50 units/bag 100 units/bag	40200-007450	

50 and 100 units/bag available upon request.

About Netafim™

Drip irrigation pioneer and global leader, Netafim delivers innovative solutions that increase crop yields and preserve scarce water resources. Netafim leverages cutting-edge, drip irrigation technologies and extensive agronomic expertise to provide end-to-end solutions for open-field crops and orchards as well as full turnkey greenhouse projects. Netafim supplies worldwide customers with agro-technical guidance, support and diverse solutions for orchards, vineyards, field crops, bio energy crops and greenhouses. Netafim's Engineering and Projects service offers customers comprehensive support with modular, tailored solutions from initial feasibility studies to post harvesting technologies. With over 2000 employees, 14 manufacturing facilities in 11 countries, Netafim boasts global sales of more than \$350 million.



Headquarters: Netafim Ltd.

Tel: +972 3 6919777 / +972 8 6474700 ■ Fax: +972 3 6911962
■ postmaster@netafim.com ■ www.netafim.com

Netafim Irrigation University

Tel: +972 4 6287779 ■ Fax: +972 4 6287210 ■ NIU@netafim.com

Irrigation & Agro Technology Research & Training Park

■ Tel: +972 4 6287572 ■ Fax: +972 4 6287718

Orchard & Vineyard - Research & Training Center

Tel: +972 4 6955543 ■ Fax: +972 4 6951221 ■ orchcenter@netafim.com

Drip Technology Center – Training and R&D Center in Hatzetim

Tel: +972 8 647 3111 ■ Fax: +972 8 642 0098 ■ eliezer.Kelmeszes@netafim.com